

iB970 English Manual  
Size: 6"W x 4 3/4" H  
Print in Black  
June 28,10

# iHome®

## iB970

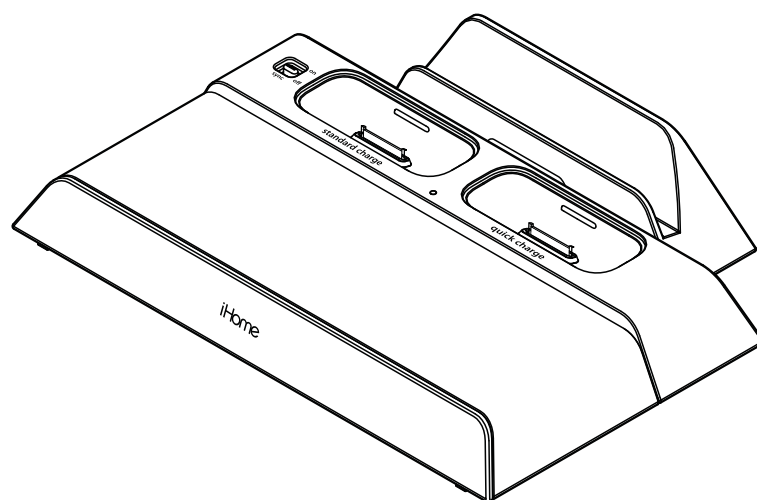

instruction manual

# iB970

## Introduction

Thank you for purchasing the iHome iB970, the dual dock charging station for iPad, iPhone and iPod that allows you to charge an iPhone or iPod in half the typical time, and to sync to a computer. There are two additional USB ports that let you connect and charge two additional devices such as an iPad, cellphones, PDAs, portable gaming systems and eBook readers at the same time. Up to four devices at once!

This instruction booklet explains the basic operation and care of the unit. Please read it carefully and keep it for future reference.

iB970

## FCC Information

**This device complies with Part 15 of the FCC Rules, operation is subject to the following two conditions: (1) This device may not cause harmful interference, and (2) this device must accept any interference received, including interference that may cause undesired operation.**

This equipment complies with the limits for a Class B digital device as specified in Part 15 of FCC Rules. These limits provide reasonable protection against radio and TV interference in a residential area.

However, your equipment might cause TV or radio interference even when it is operating properly. To eliminate interference you can try one or more of the following corrective measures:

- Reorient or relocate the receiving antenna.
- Increase the distance between the equipment and the radio or TV.
- Use outlets on different electrical circuits for the equipment and the radio or TV.
- Consult your dealer or an experienced radio/television technician if the problem still exists.

Modifying or tampering with your system's internal components can cause a malfunction and might invalidate the system's warranty and void your FCC authorization to operate it.

This Class B digital apparatus complies with Canadian ICES-003.

Cet appareil numérique de la classe B est conforme à la norme NMB-003 du Canada.

## Using the iB970

### Table of Contents

Meet Your iB970 .....	1-2
Getting Started .....	3
Charging iPhone and iPod .....	4-5
Syncing iPhone or iPod to a Computer .....	5
Charging iPad and other Devices Using the USB Ports.....	6-8
Consumer Safety and Product Maintenance.....	9-10
Troubleshooting .....	11
Warranty.....	12

# iB970

## Meet Your iB970

### Top

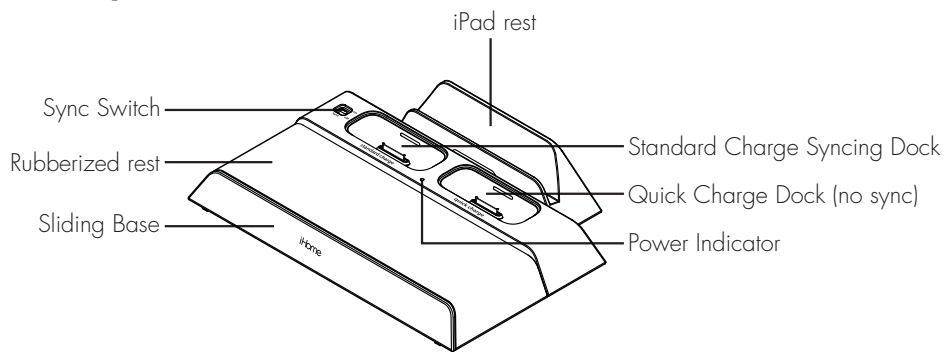

### Rear

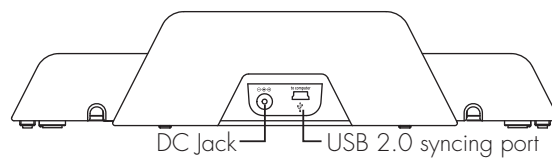





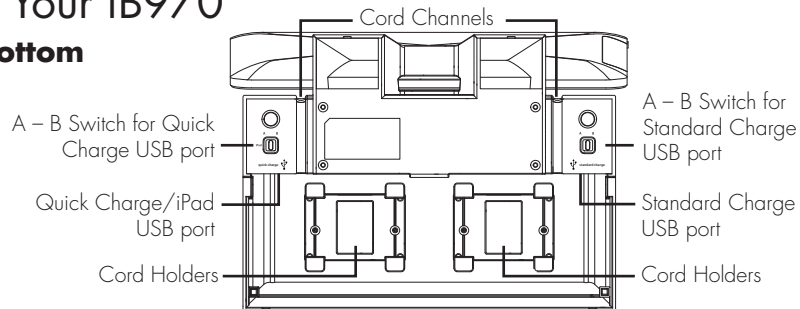

# iB970

## Meet Your iB970

### Bottom



### Included Cables

- 36 inch sync cable (to sync iPhone/iPod to computer)  

- 12 inch USB to mini USB cable (to charge compatible devices)  

- 12 inch USB to 4mm plug (to charge Sony eReader and Sony PSP game systems)  

- 1 mini USB to micro USB adapter  

- 12" black cable with USB plug to Nintendo DSi/DSi XL plug  

- 12" black cable with USB plug to Nintendo DS Lite plug  

- 12" black cable with USB plug to Nintendo DS plug  

### Included Inserts

- 2 iPhone inserts



## Using the iB970

### Getting Started

1. Plug the 100V - 240V universal switching AC adapter into the DC jack on the rear of the iB970 and the other end into a working outlet. A blue LED indicator will light up, indicating the unit has power and is ready to charge. If the blue light does not appear, try activating any wall switch that controls the outlet, or try using another outlet.

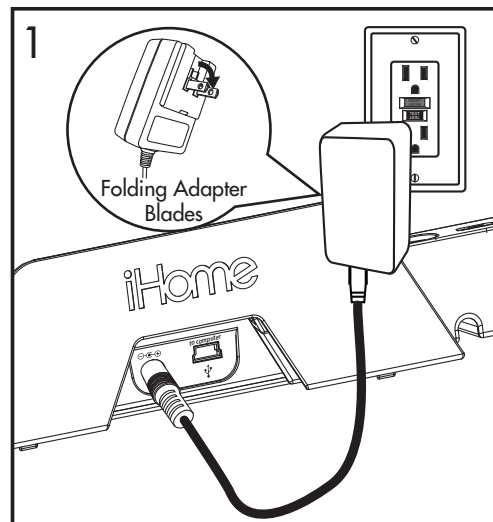

## iB970

### Charging iPhone and iPod

The iB970 has two universal docks for iPhone or iPod.

**The left dock is a standard charging dock with sync** that will recharge your iPhone or iPod and lets you sync your iPhone or iPod to the iTunes library on your computer if desired.

**The right dock provides quick charging without sync.**

The docks will charge your iPhone or iPod until completely charged then stop charging. Use both docks to charge two devices at once.

1. Make sure the unit is connected to a working power source
2. Place the insert that came with your iPod into the desired dock. If using an iPhone, use the iPhone insert provided with the iB970.

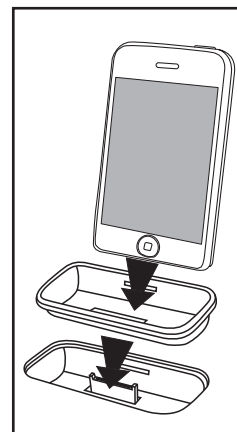

NOTE: If you do not have an insert for your iPod, please visit [www.ihomeaudio.com](http://www.ihomeaudio.com) (or call iHome toll free at 800-288-2792) to purchase one



## iB970

3. Gently dock an iPhone or iPod into the desired dock on top of the unit. Do not force. Make sure your iPhone or iPod is not in a case or "skin". To avoid damage to your iPhone or iPod, never dock an iPhone or iPod without using an insert. Avoid using undue pressure when placing and removing iPhone or iPod from dock(s). Your docked iPhone or iPod will charge until fully charged.

### Syncing iPhone and iPod to an iTunes Library on Your Computer

1. Connect the small end of the included **Sync Cable** to the **Sync Jack** on the rear of the unit and the other end into a USB port on your computer.
2. Slide the **Sync Switch** located on the top left of the unit to the ON position. Your iPhone or iPod will begin syncing with your computer.  
**DO NOT disconnect the Sync Cable or move the Sync Switch during sync function.** A notice should appear on your computer display when sync is complete and it is safe to disconnect.
3. Gently dock an iPhone or iPod into the left dock on top of the unit (see above).
4. Once sync is complete, return the Sync Switch to the OFF position.

**NOTE:** A docked iPhone/iPod will not charge if the sync cable is not connected to a computer while the Sync Switch is in the ON position

## Using the iB970

### Charging iPad and other Devices Using the USB Ports

The iB970 has two additional USB ports on the bottom of the unit, one quick-charging USB port (left) for iPad and other devices and one standard charging USB port (right) that can charge most USB-compatible devices such as Blackberries, eBook readers, portable gaming systems, etc., allowing you to charge two additional devices at once. Each port has a **USB Mode Switch** (A–B) to accommodate the different USB-powered devices.

#### Charging Devices

- A. **position:** Will charge iPad and most iPod and iPhone models.
- B. **position:** Will charge Sony Reader™, Amazon Kindle™, Barnes & Noble Nook™, Border's kobo™, Blackberry, Nintendo DS/DS Lite/DSi/DSi XL™, Sony PSP™/PSP go and other devices.

If device does not charge, move USB Mode Switch to A position to see if it charges.

If device still does not charge, try unplugging the device from the USB port then reconnecting it.

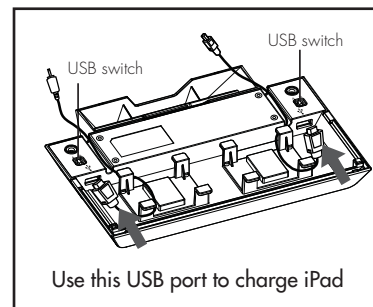

## Using the iB970

1. Make sure unit is connected to a working power source
2. Connect one end of a USB cable (several are included) to either USB port on the bottom of the iB970 and the other into the USB port on your device (see page 2 to match cables with devices). If needed, use the included USB converter tip to match your device's port.
3. If needed, slide out the rubberized rest to fit your device.
4. Monitor your device's battery indicator to confirm the device is charging. If the device is NOT charging, try moving the **USB Mode Switch** to a different position. If the device still does not charge, try unplugging the device from the USB port then reconnecting it

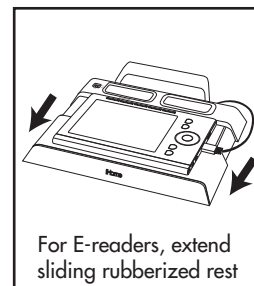
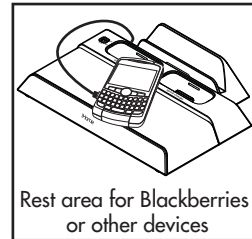

## Using the iB970

### **To charge your iPad,**

1. Connect your USB - 30 pin cable to the left USB port and move the USB mode switch for that port to the "A" position before placing your iPad in the iPad rest.
2. Place your iPad in the iPad rest as shown.
3. Connect the 30-Pin plug to the 30-Pin jack on the bottom of your iPad as shown.

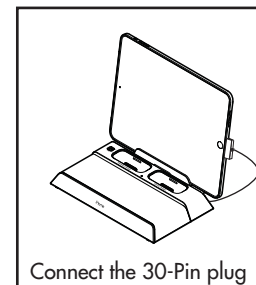
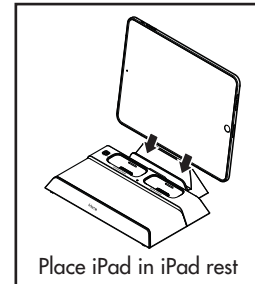

## Consumer Product Safety Guide

When used in the directed manner, this unit has been designed and manufactured to ensure your personal safety. However, improper use can result in potential electrical shock or fire hazards. Please read all safety and operating instructions carefully before installation and use, and keep these instructions handy for future reference. Take special note of all warnings listed in these instructions and on the unit.

1. **Water and Moisture** – The unit should not be used near water. For example: near a bathtub, washbowl, kitchen sink, laundry tub, swimming pool or in a wet basement.
2. **Ventilation** – The unit should be situated so that its location or position does not interfere with its proper ventilation. For example, it should not be situated on a bed, sofa, rug or similar surface that may block ventilation openings. Also, it should not be placed in a built-in installation, such as a bookcase or cabinet, which may impede the flow of air through the ventilation openings.
3. **Heat** – The unit should be situated away from heat sources such as radiators, heat registers, stoves or other appliances (including amplifiers) that produce heat.
4. **Power Sources** – The unit should be connected to a power supply only of the type described in the operating instructions or as marked on the appliance.
5. **Power-Cable Protection** – Power supply cables should be routed so that they are not likely to be walked on or pinched by items placed upon or against them. It is always best to have a clear area from where the cable exits the unit to where it is plugged into an AC socket.
6. **Cleaning** – The unit should be cleaned only using a warm damp cloth. Do not use solvents, etc.
7. **Objects and Liquid Entry** – Care should be taken so that objects do not fall and liquids are not spilled into any openings or vents located on the product.

8. **Attachments** – Do not use attachments not recommended by the product manufacturer.
9. **Lightning and Power Surge Protection** – Unplug the unit from the wall socket and disconnect the antenna or cable system during a lightning storm or when it is left unattended and unused for long periods of time. This will prevent damage to the product due to lightning and power-line surges.
10. **Overloading** – Do not overload wall sockets, extension cords, or integral convenience receptacles as this can result in a risk of fire or electric shock.
11. **Damage Requiring Service** – The unit should be serviced by qualified service personnel when:
  - A. the power supply cable or plug has been damaged.
  - B. objects have fallen into or liquid has been spilled into the enclosure.
  - C. the unit has been exposed to rain.
  - D. the unit has been dropped or the enclosure damaged.
  - E. the unit exhibits a marked change in performance or does not operate normally.
12. **Periods of Nonuse** – If the unit is to be left unused for an extended period of time, such as a month or longer, the power cable should be unplugged from the unit to prevent damage or corrosion.
13. **Servicing** – The user should not attempt to service the unit beyond those methods described in the user's operating instructions. Service methods not covered in the operating instructions should be referred to qualified service personnel.

**Questions? Visit [www.ihomeaudio.com](http://www.ihomeaudio.com)  
or call 1-800-288-2792 Toll Free**

Nintendo DS/DS Lite/DSi/DSi XL, Sony PSP/PSP go, Blackberry, Sony Reader, Amazon Kindle, Barnes & Noble Nook,  
and Borders Kobo are trademarks of their respective companies.

## Troubleshooting

### **Unit doesn't respond (no power)**

Make sure AC adaptor is connected to unit and is plugged into a working outlet (plug another device into the same outlet to confirm outlet is working, and make sure any associated power switch is ON).

### **iPhone/iPod/iPad does not charge**

Make sure you have the latest firmware for your iPad, iPhone or iPod (update via iTunes if needed). Make sure your device is working properly. Check your iPhone or iPod manual for details. iPad must be connected to the quick charge/iPad port on the bottom left of the unit to charge. Make sure the Sync Switch is in OFF position when unit is not connected to a computer for syncing

### **USB device won't charge**

1. Make sure all connections are proper and secure
  2. Monitor charging indicator on your device.
  3. Move the USB Mode Switch to a different position.
  4. Unplug device from USB port then reconnect it.
- For further information, visit [www.ihomeaudio.com](http://www.ihomeaudio.com)

## Limited 1 Year Warranty

iHome Products, a division of SDI Technologies Inc. (hereafter referred to as SDI Technologies), warrants this product to be free from defects in workmanship and materials, under normal use and conditions, for a period of 1 year from the date of original purchase. Should this product fail to function in a satisfactory manner, it is best to first return it to the store where it was originally purchased. Should this fail to resolve the matter and service still be required by reason of any defect or malfunction during the warranty period, SDI Technologies will repair or, at its discretion, replace this product without charge (except for a \$10.00 charge for handling, packing, return UPS/postage, and insurance). This decision is subject to verification of the defect or malfunction upon delivery of this product to the Factory Service Center listed below. The product must include proof of purchase, including date of purchase. The fee for service without proof of purchase is \$20.00.

Before returning this product for service, please first replace the batteries (if applicable) with fresh ones, as exhausted or defective batteries are the most common cause of problems encountered.

If service is still required:

1. Remove the batteries (if applicable) and pack the unit in a well padded, heavy corrugated box.
2. Enclose a photocopy of your sales receipt, credit card statement, or other proof of the date of purchase, if within the warranty period.
3. Enclose a check or money order payable to the order of SDI Technologies, for the sum of \$10.00 (\$20.00 without proof of purchase).
4. Send the unit prepaid and insured, to the Factory Service Center listed below.

### **Consumer Repair Department**

*SDI Technologies Inc.  
1330 Goodyear Drive  
El Paso, TX 79936-6420*

### Disclaimer of Warranty

**NOTE:** This warranty is valid only if the product is used for the purpose for which it was designed. It does not cover (i) products which have been damaged by negligence or willful actions, misuse or accident, or which have been modified or repaired by unauthorized persons; (ii) cracked or broken cabinets, or units damaged by excessive heat; (iii) damage to digital media players, CD's or tape cassettes (if applicable); (iv) the cost of shipping this product to the Factory Service Center and its return to the owner.

This warranty is valid only in the United States of America and does not extend to owners of the product other than to the original purchaser. In no event will SDI Technologies or any of its affiliates, contractors, resellers, their officers, directors, shareholders, members or agents be liable to you or any third party for any consequential or incidental damages, any lost profits, actual, exemplary or punitive damages. (Some states do not allow limitations on implied warranties or exclusion of consequential damages, so these restrictions may not apply to you.) This warranty gives you specific legal rights, and you may also have other rights which vary from state to state.

Your acknowledgement and agreement to fully and completely abide by the above mentioned disclaimer of warranty is contractually binding to you upon your transfer of currency (money order, cashier's check, or credit card) for purchase of your SDI Technologies product.

© 2010 SDI Technologies, Inc. All rights reserved

**Questions? Visit [www.ihomeaudio.com](http://www.ihomeaudio.com) or call 1-800-288-2792 Toll Free.**

iB970062810A

©SDI Technologies 2010 All rights Reserved

Printed in China